

|        |         |        |        |        |        |           |
|--------|---------|--------|--------|--------|--------|-----------|
|        |         |        |        |        |        |           |
| 33   A | 33   B  | 33   C | 38   D | 24   E | 14   F | 3 kpl   N |
|        |         |        |        |        |        |           |
| 2   G  | W3,5x13 | 1   I  | 2   J  | W4x30  | 1   L  | 1   M     |

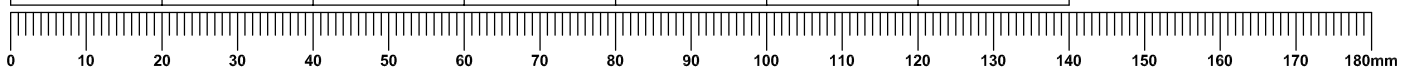

1

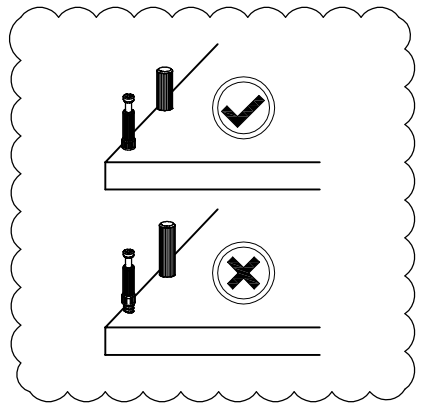

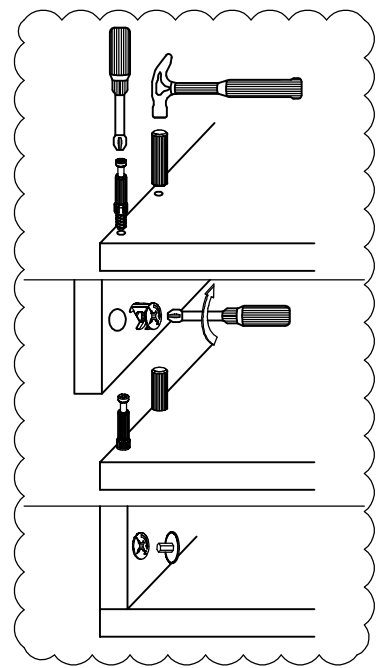
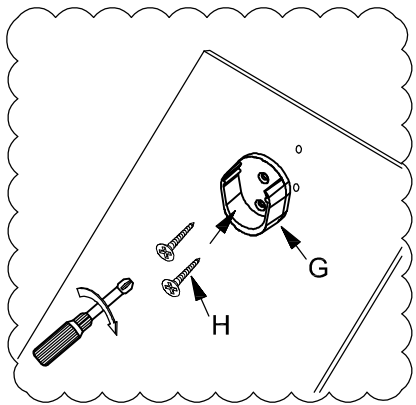
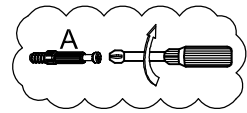
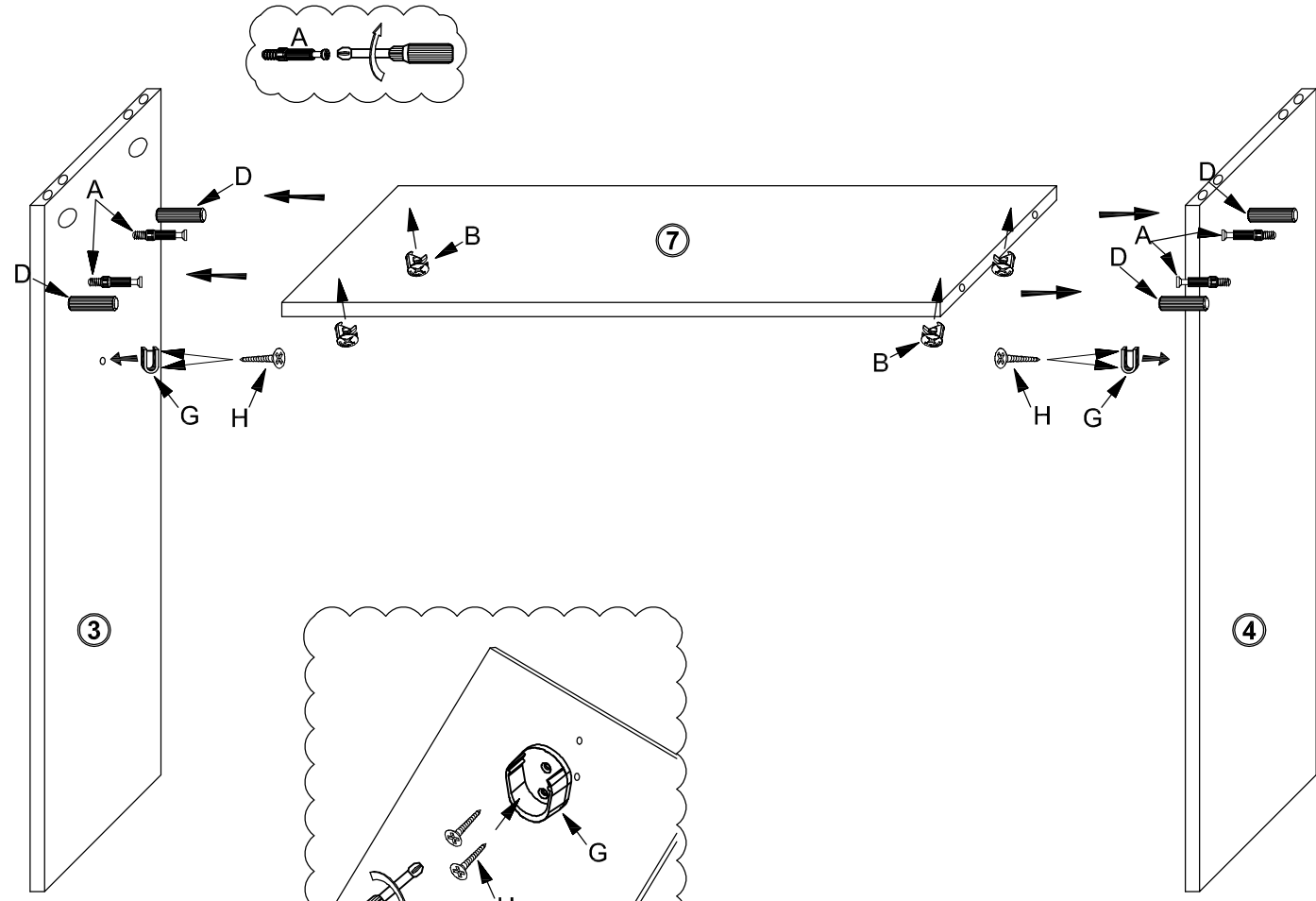

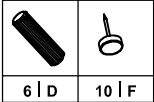
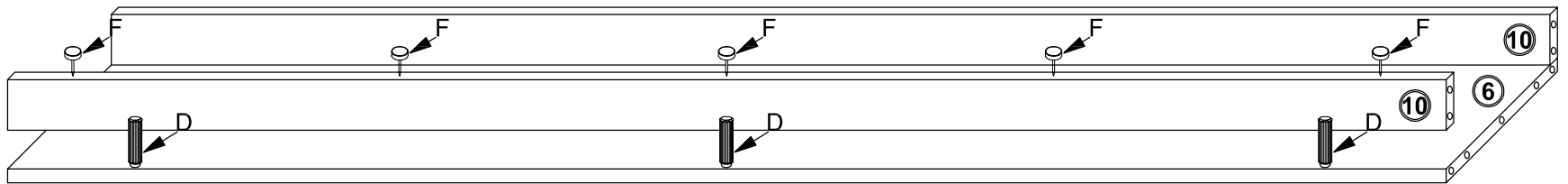
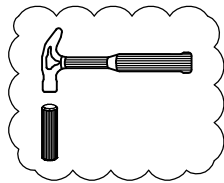
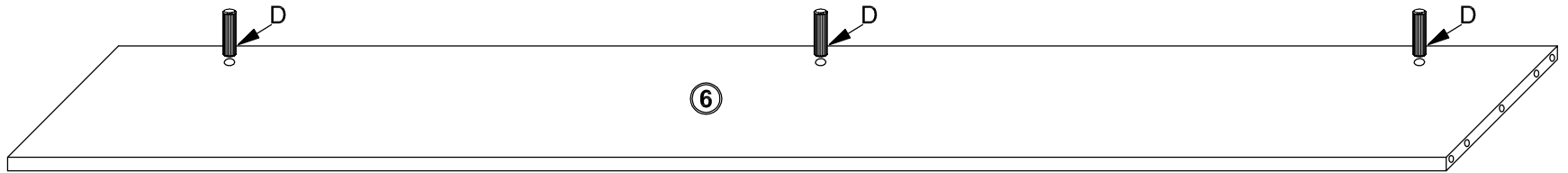
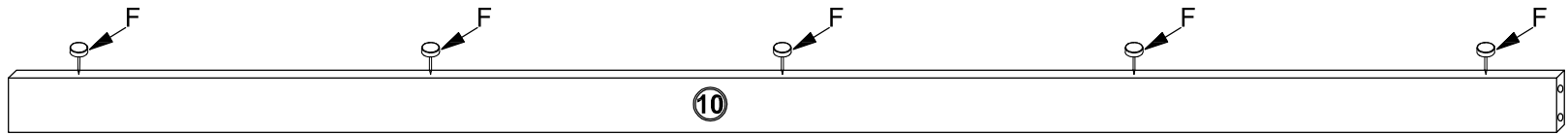

|       |       |       |       |       |       |
|-------|-------|-------|-------|-------|-------|
|       |       |       |       |       |       |
| 4   A | 4   B | 4   C | 4   D | 2   G | 4   H |

W3,5x13

2



3

|  |   |   |   |
|--|---|---|---|
|  |  |  |  |
| 12   A   | 12   B  | 12   C  | 8   D   |

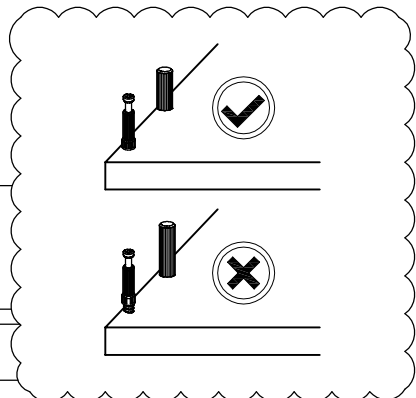
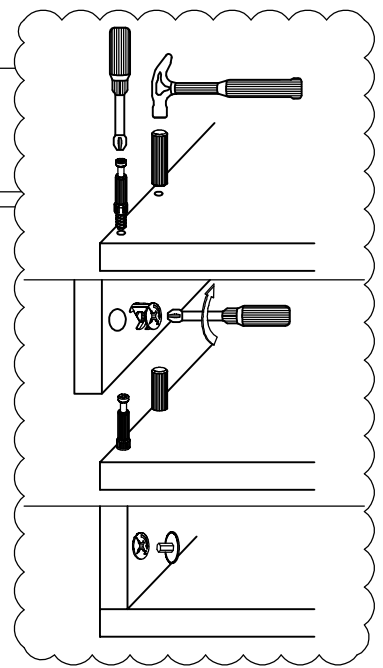
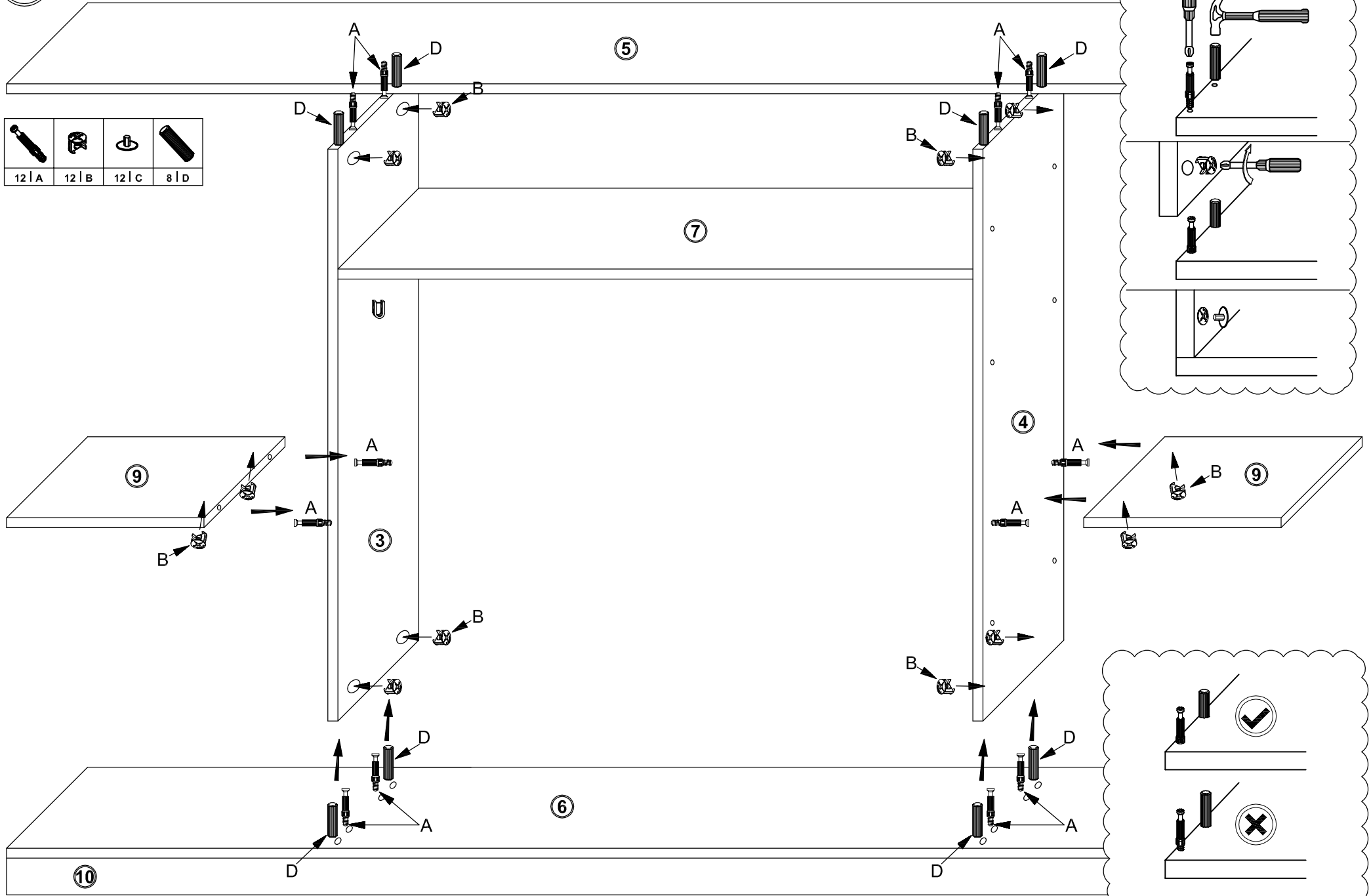

4

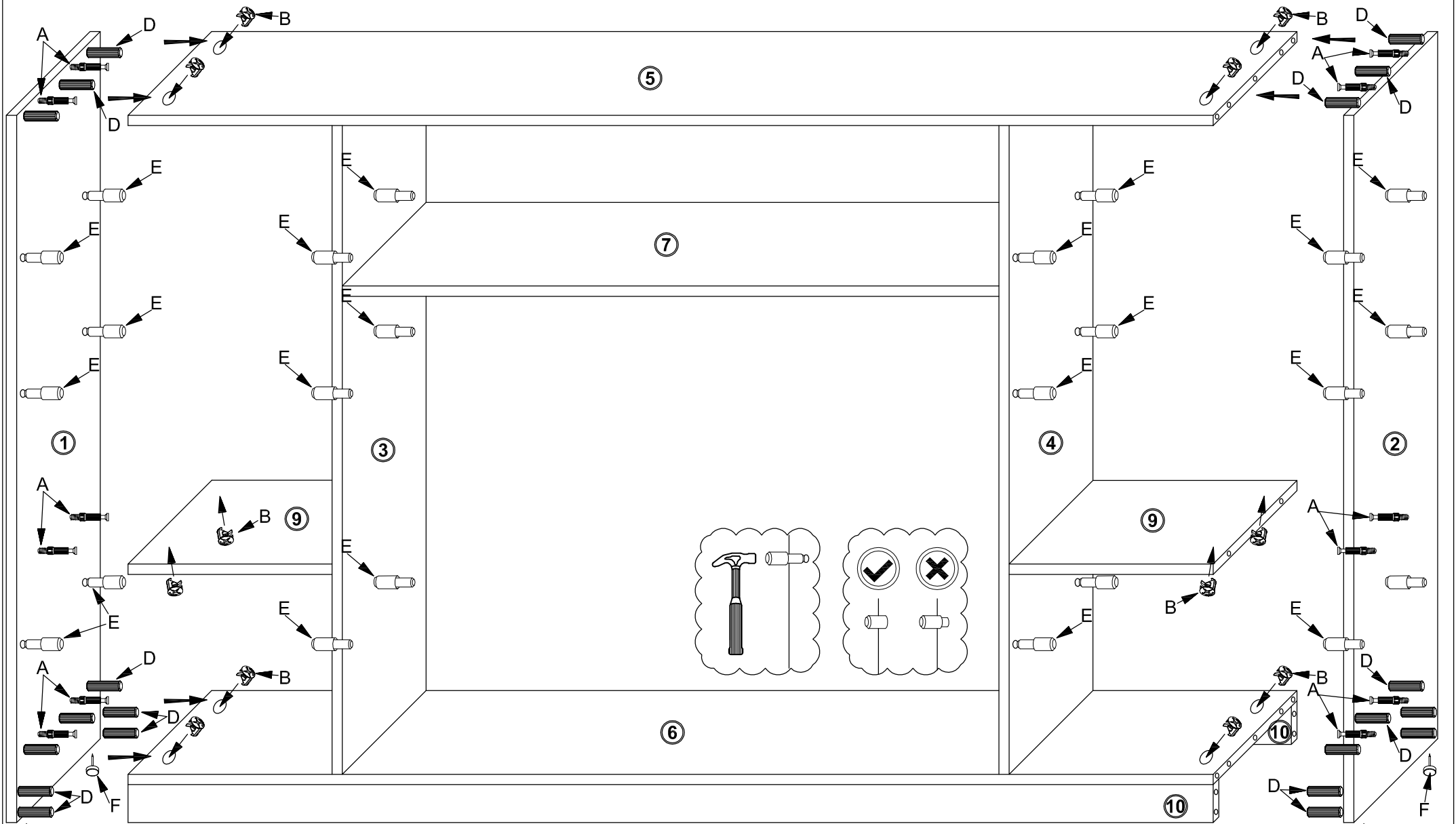

|        |        |        |        |        |       |
|--------|--------|--------|--------|--------|-------|
|        |        |        |        |        |       |
| 12   A | 12   B | 12   C | 20   D | 24   E | 4   F |

5

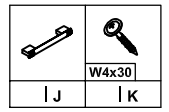
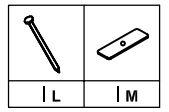
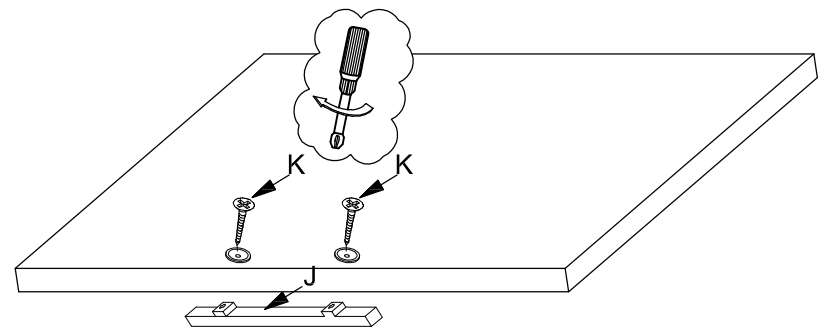
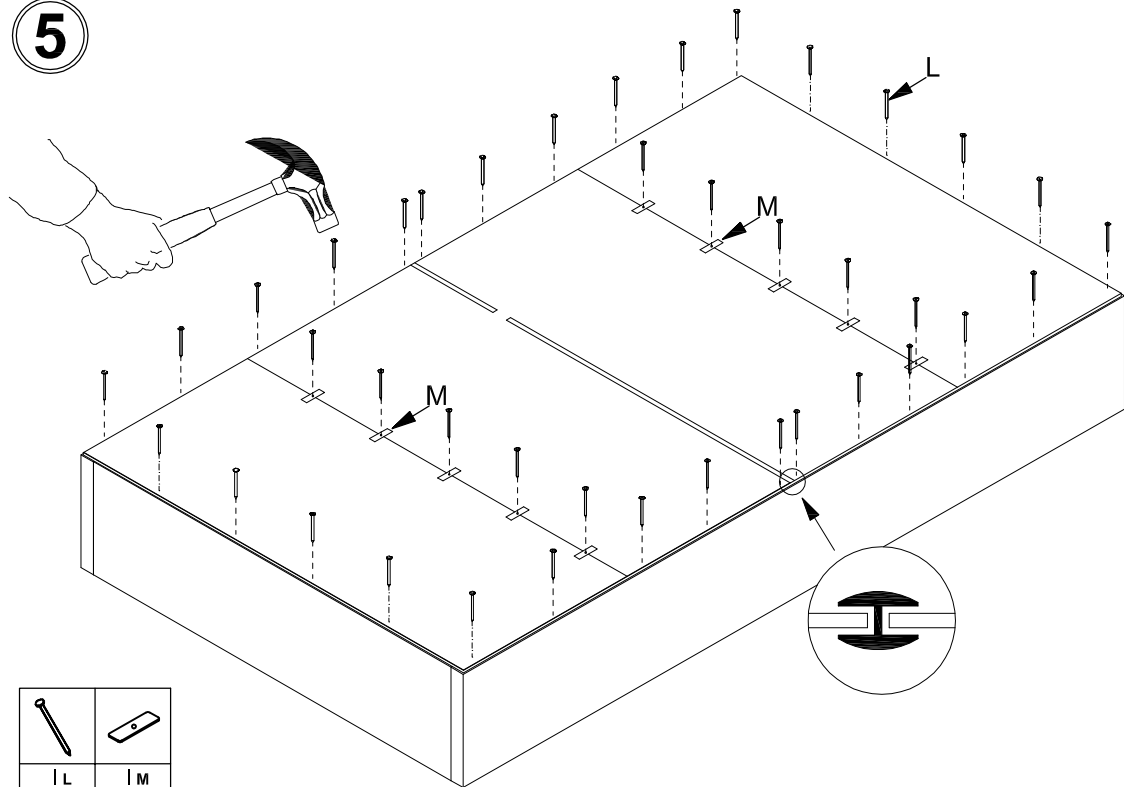

6

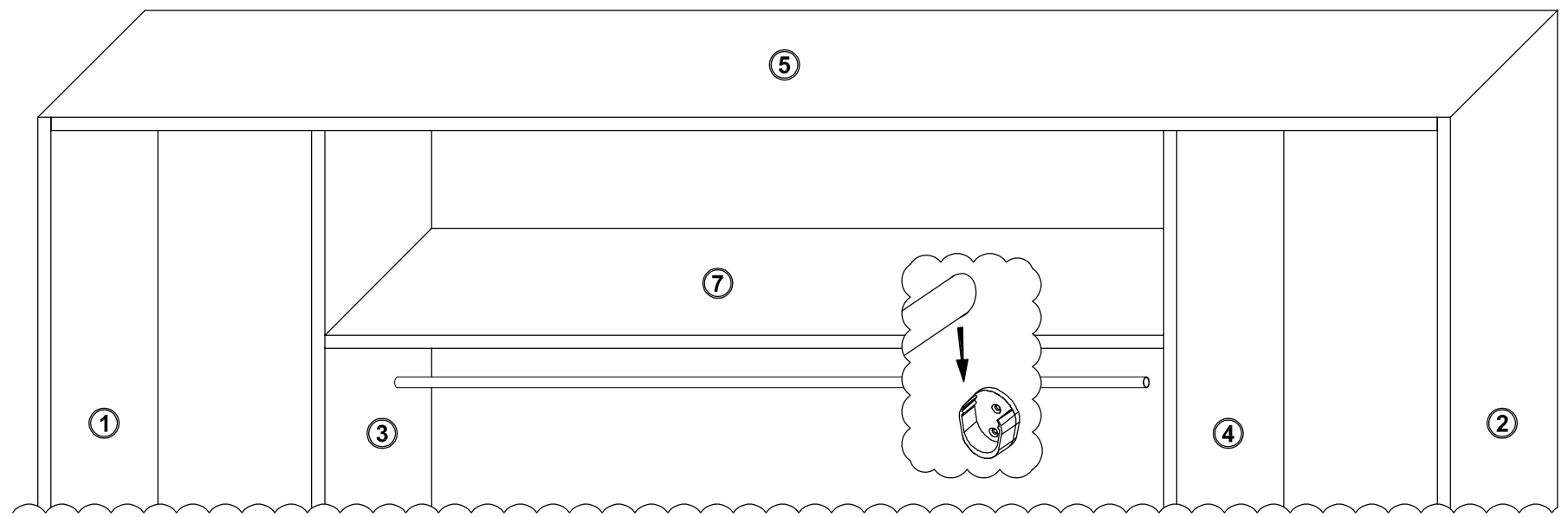

7

1

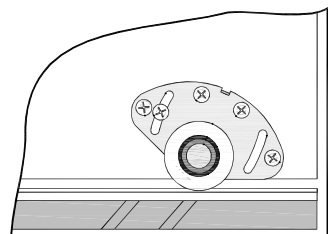
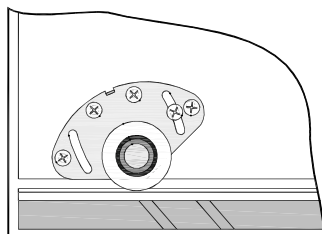
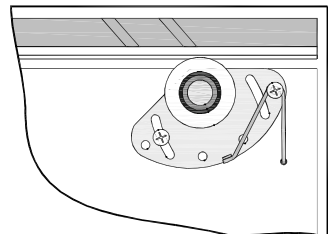
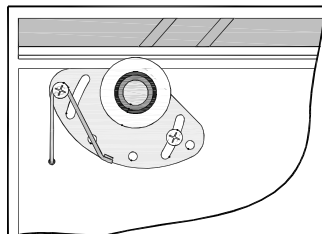
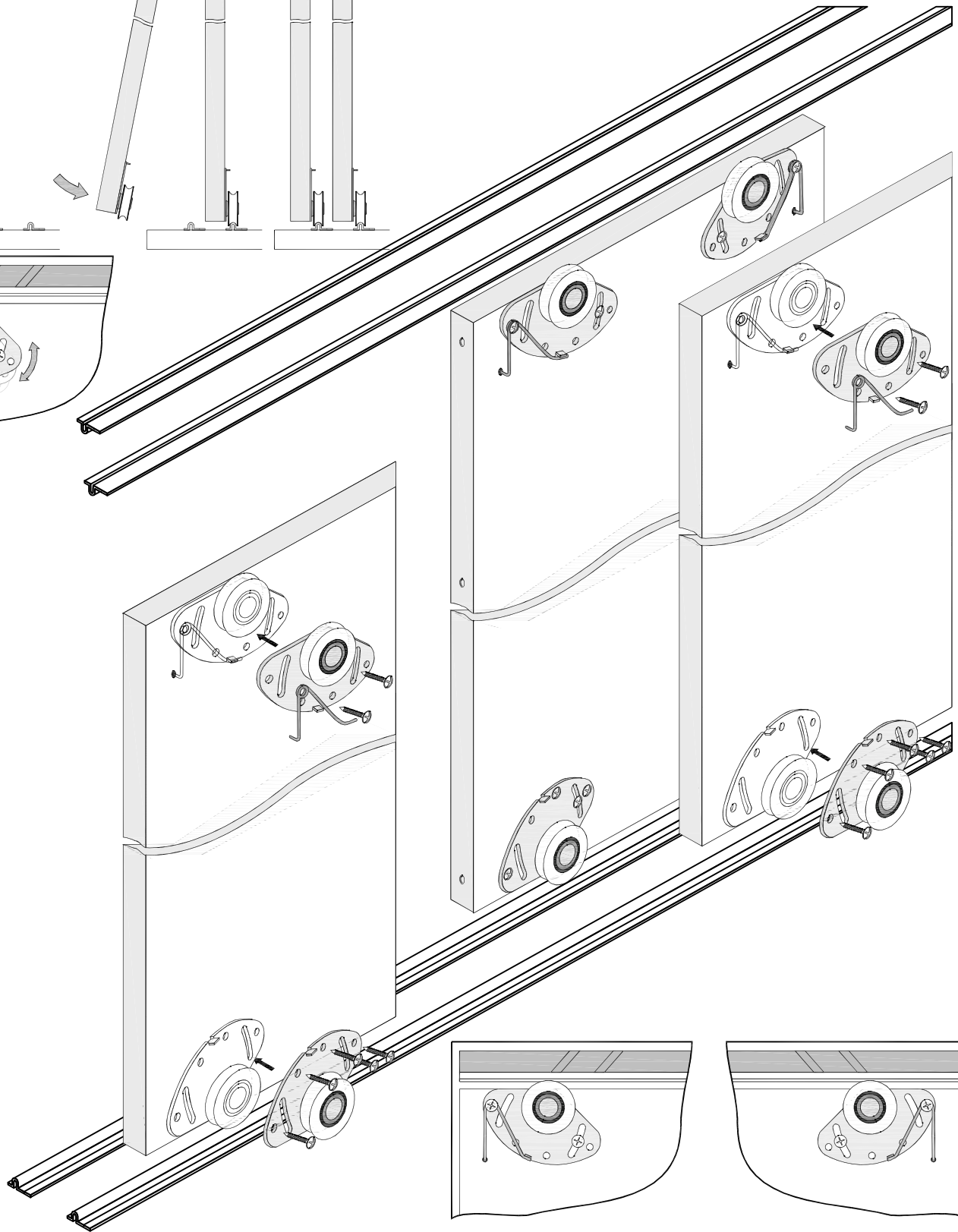
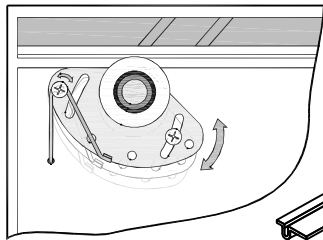
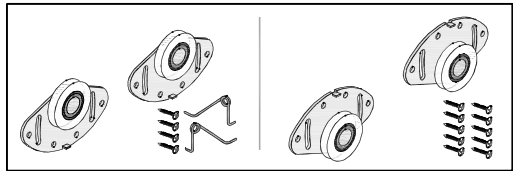

2

3

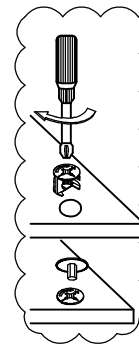
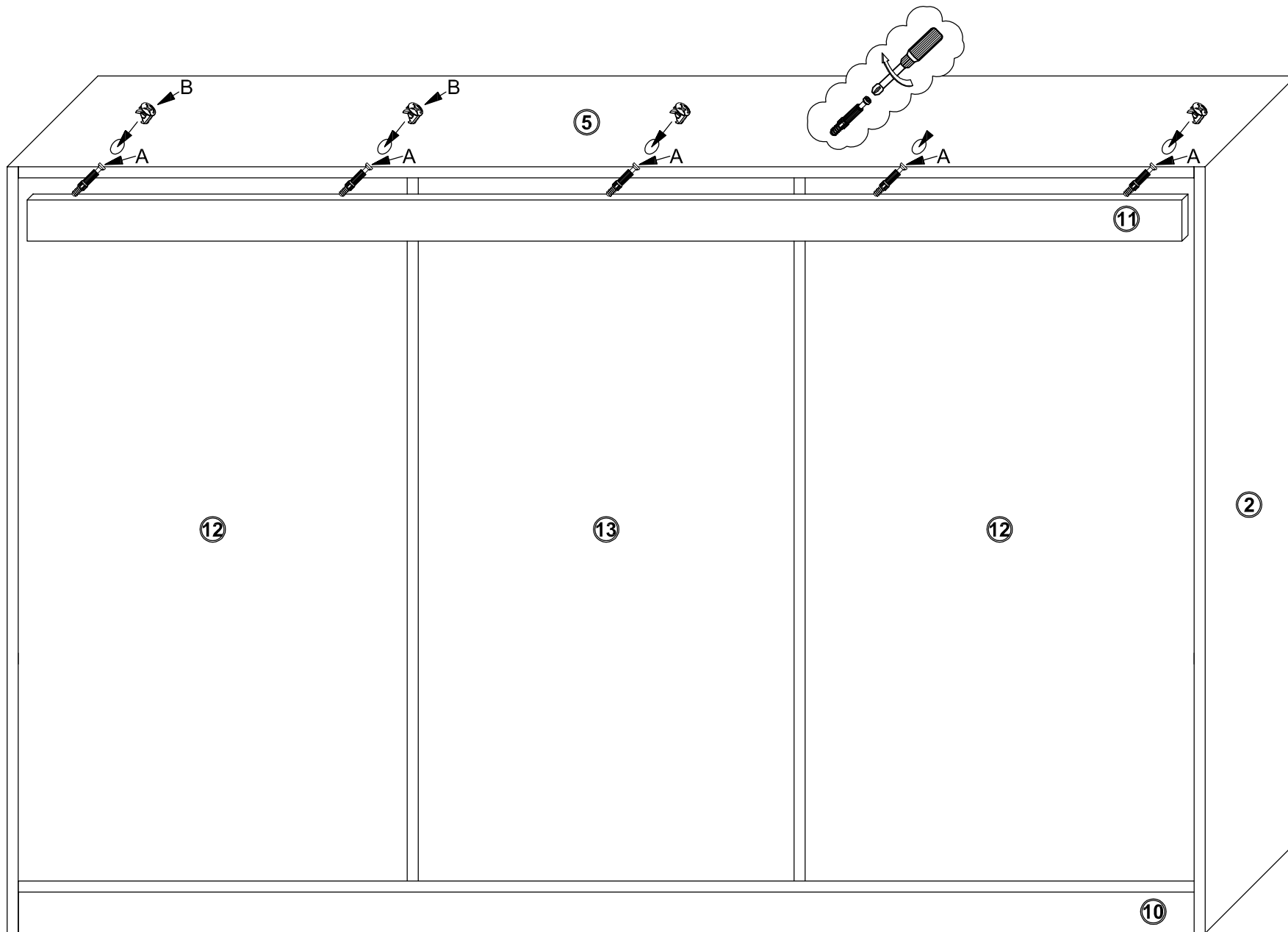

8



|   |   |   |
|---|---|---|
|  |  |  |
| 5   A   | 5   B   | 5   C   |