

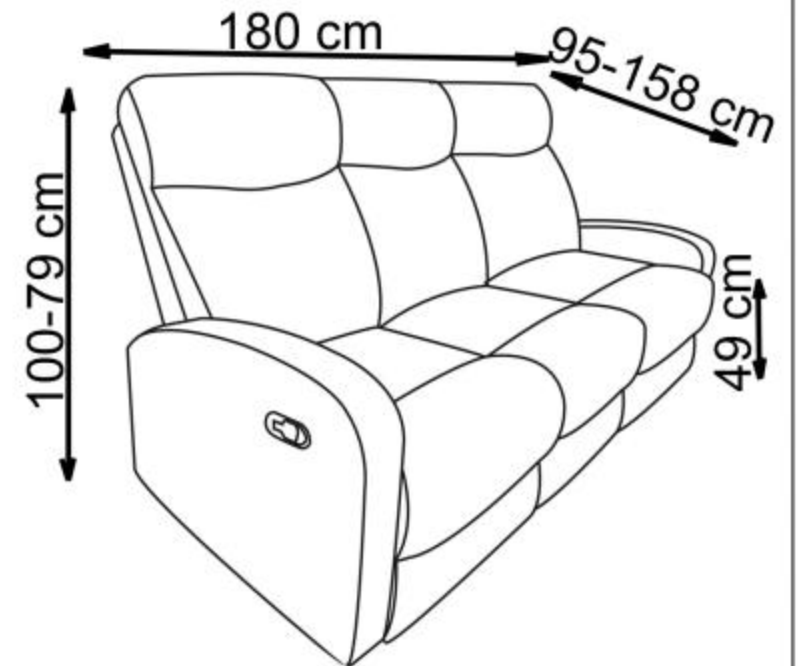

A		1
B		3

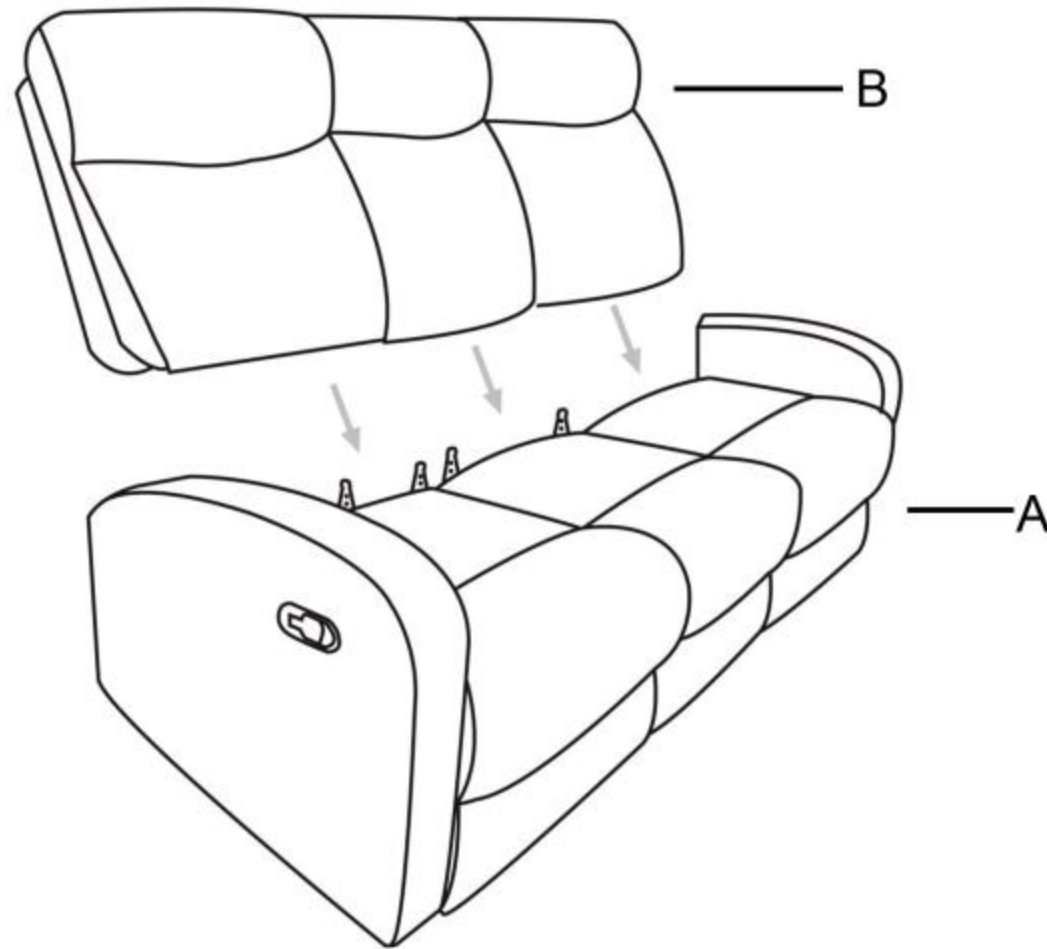

 max. 300kg