

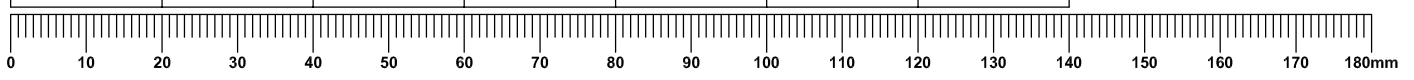

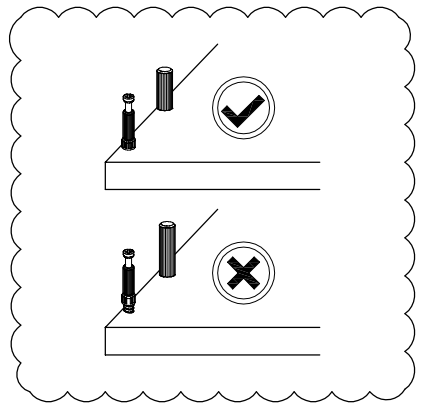

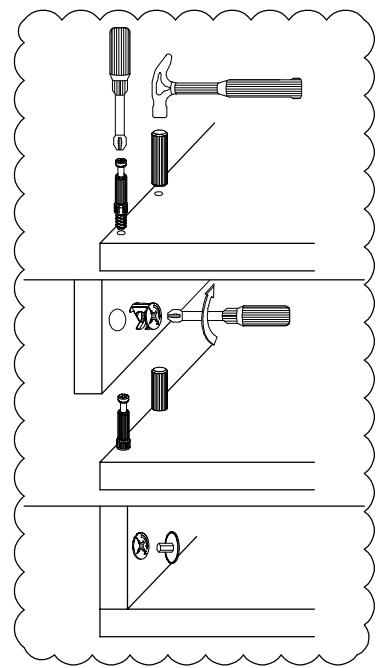

33 A	33 B	33 C	38 D	24 E	14 F	
2 kpl N	2 G	1 I	4 K	1 L	1 M	1 N

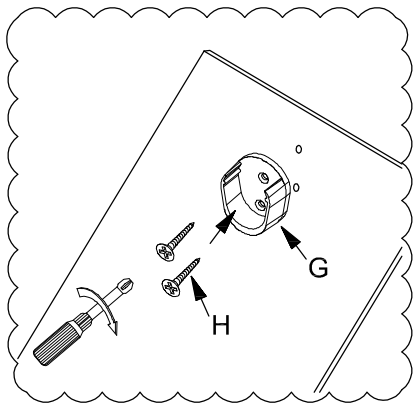
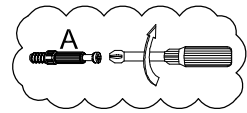
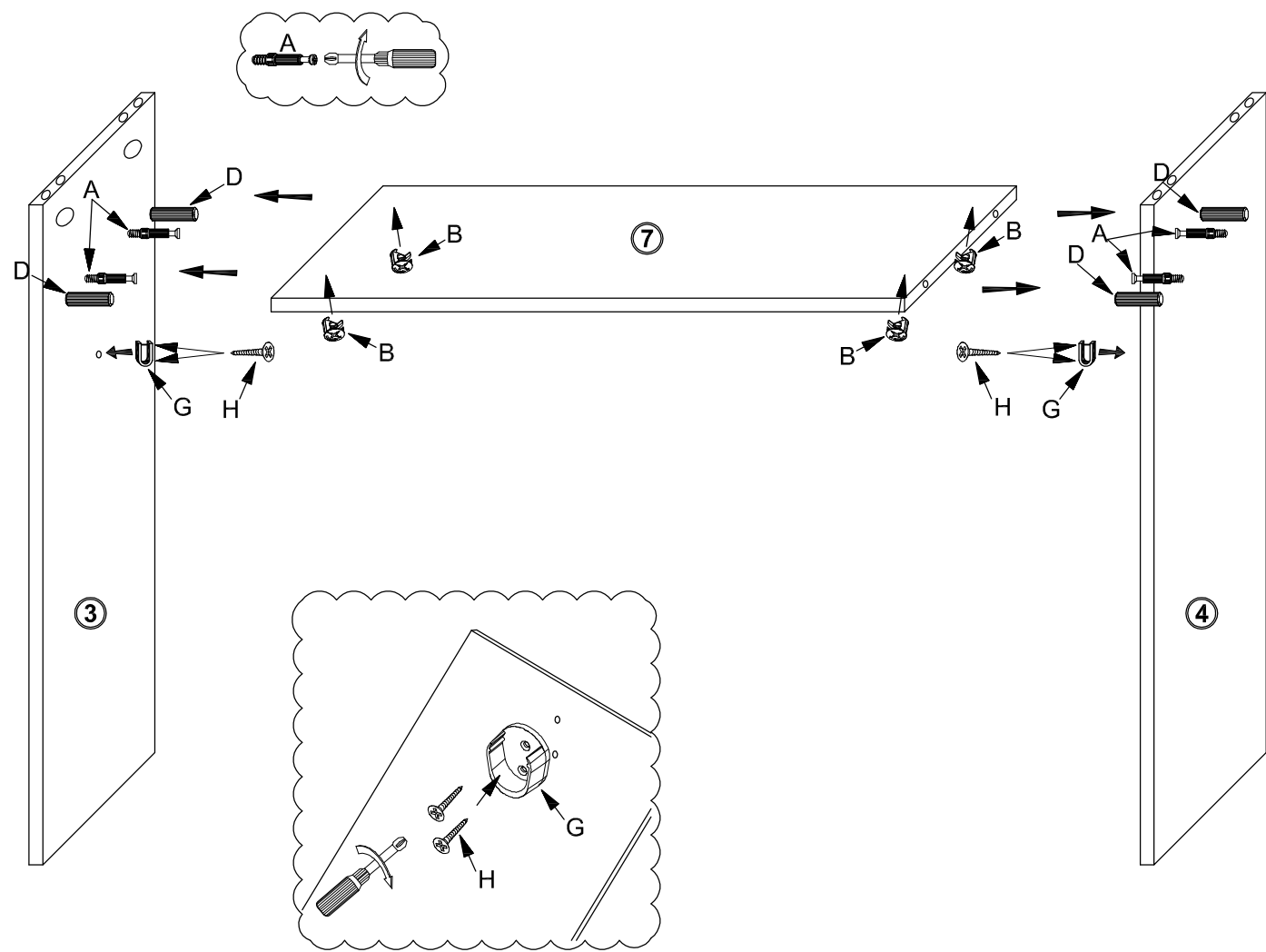

1





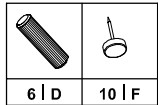
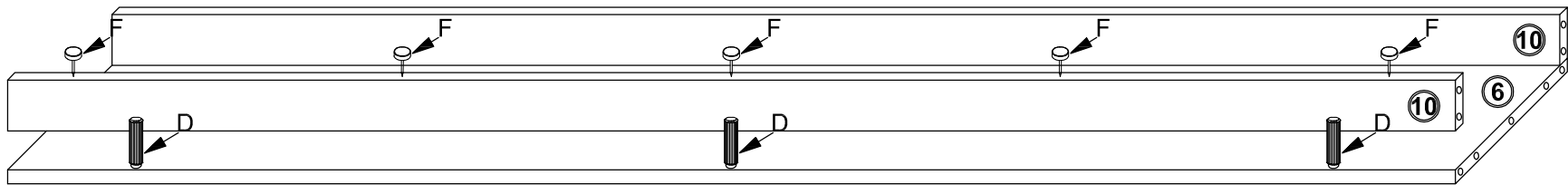
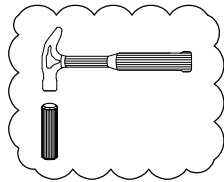
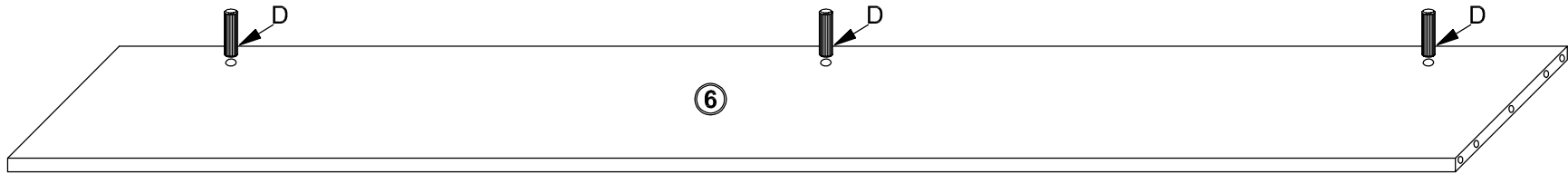
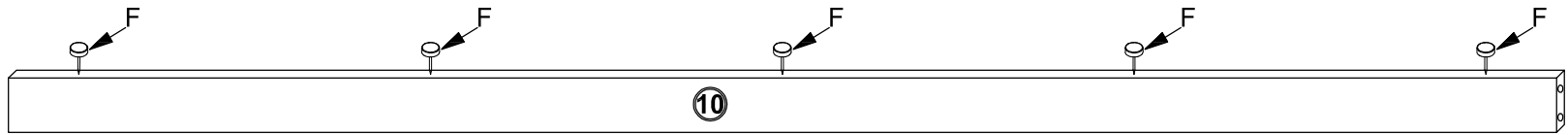

					
4 A	4 B	4 C	4 D	2 G	4 H

W3,5x13

2



3

			
12 A	12 B	12 C	8 D

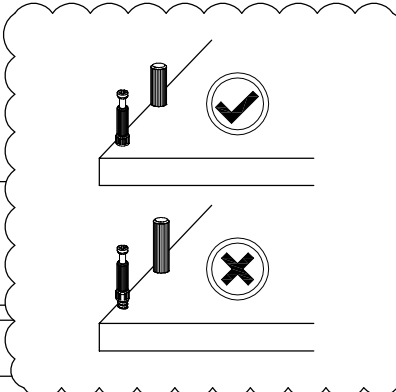
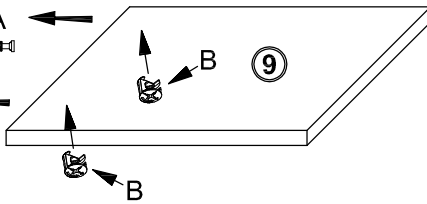
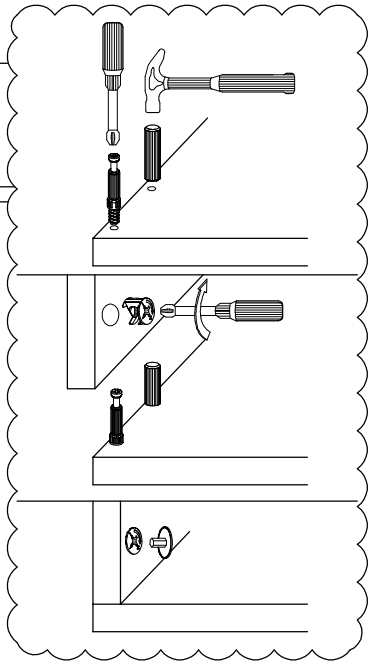
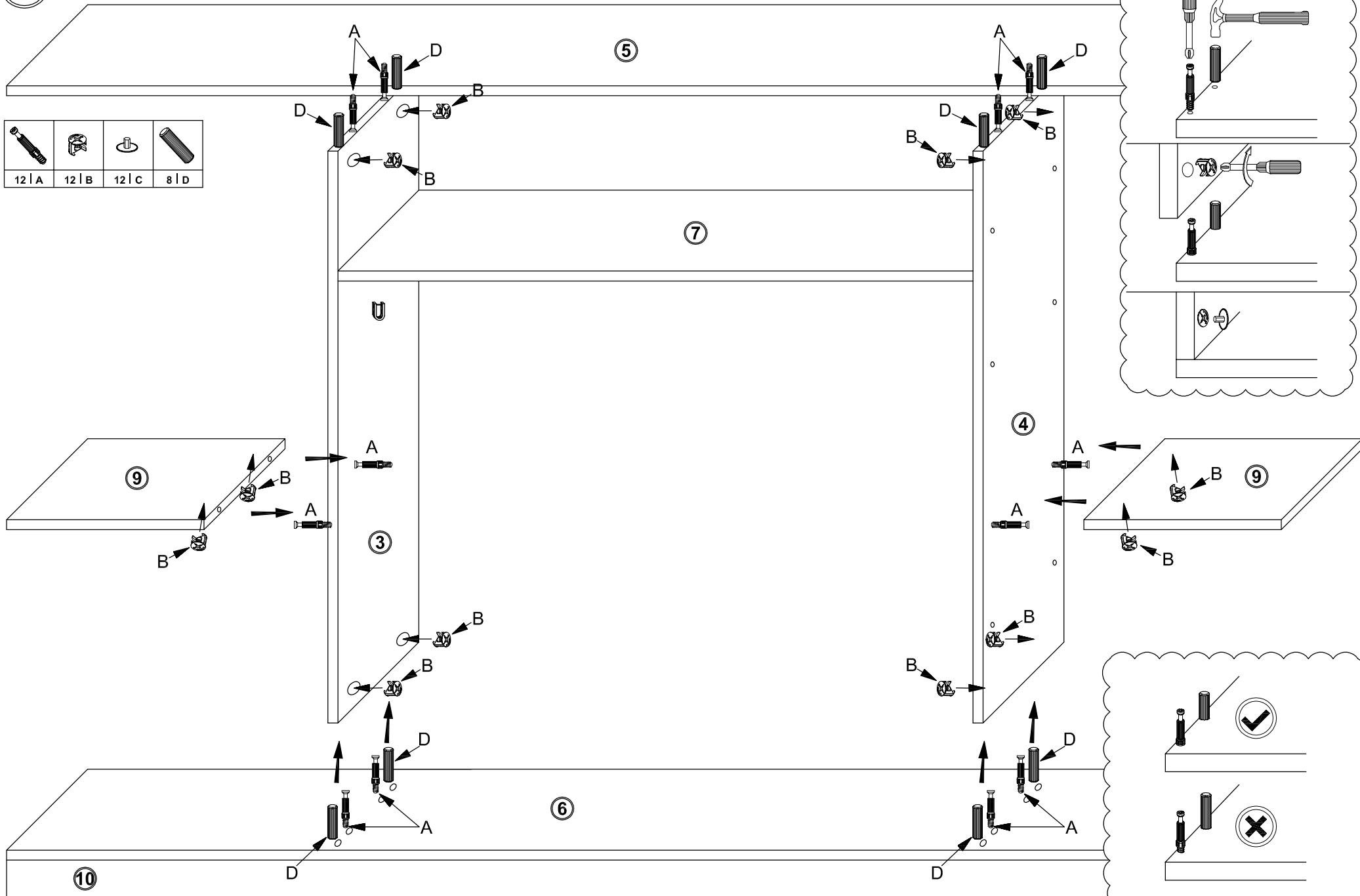

4

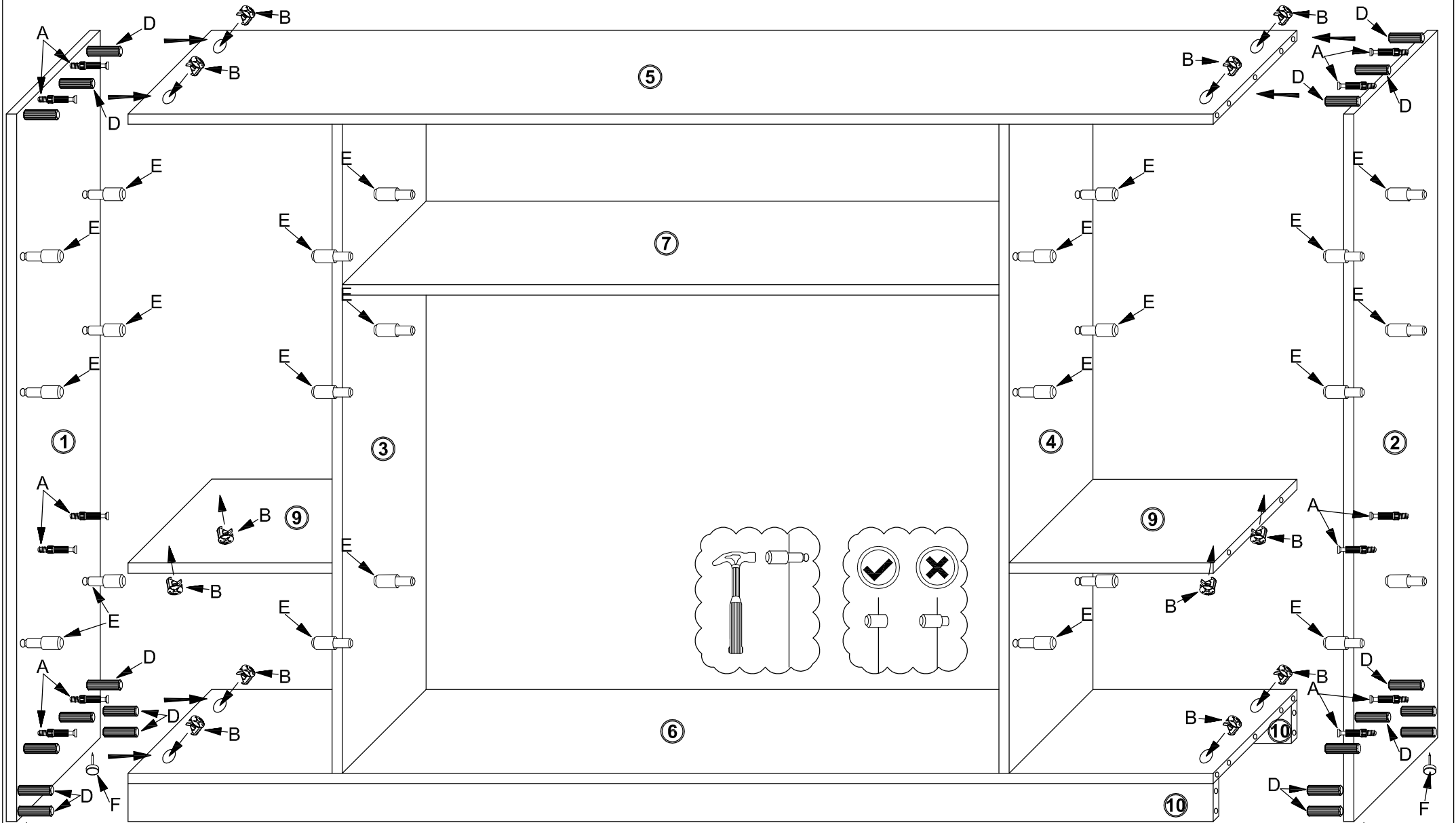

12 A	12 B	12 C	20 D	24 E	4 F

5



A = B

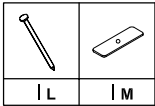
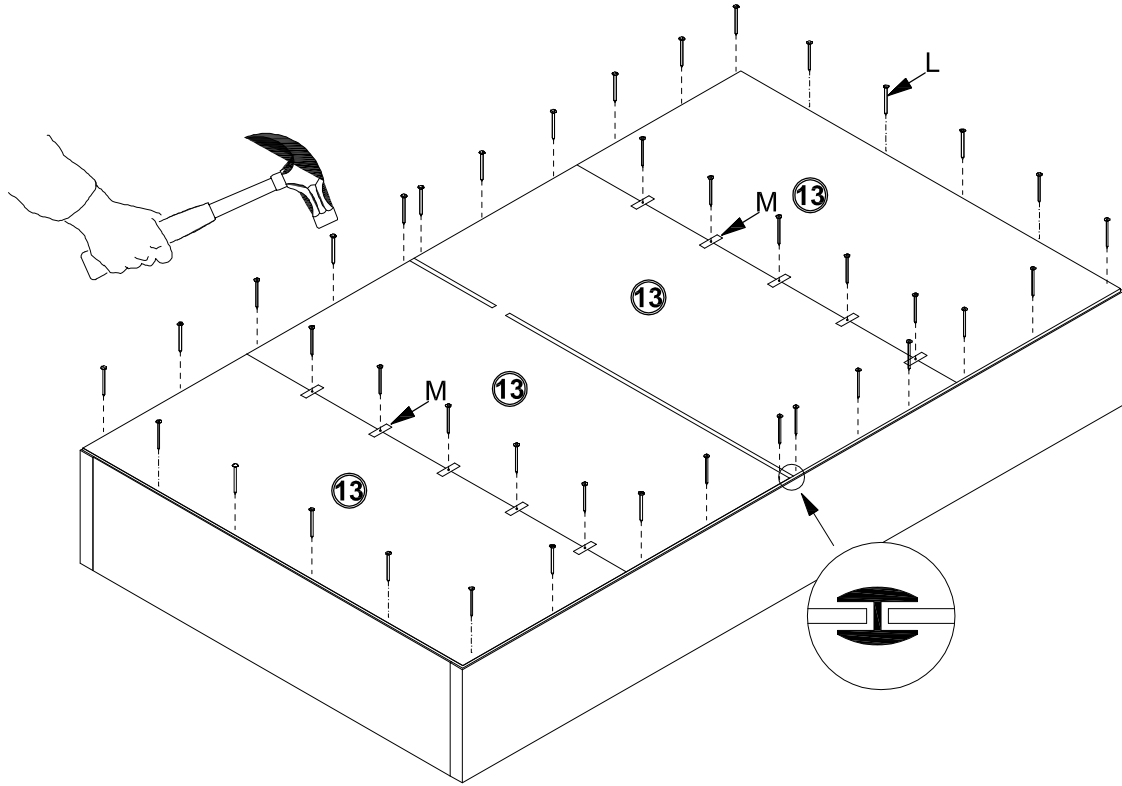
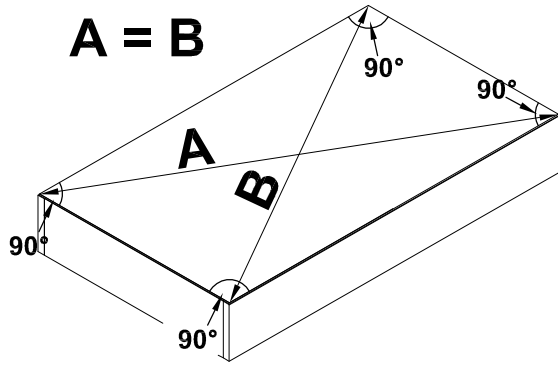

6

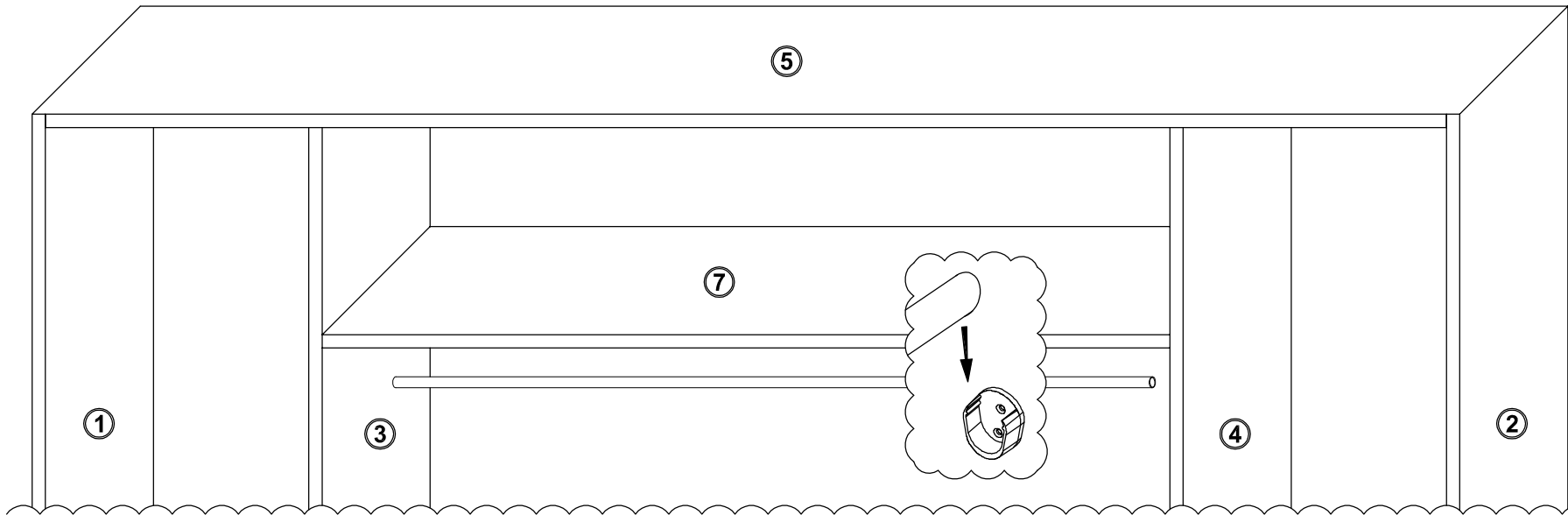

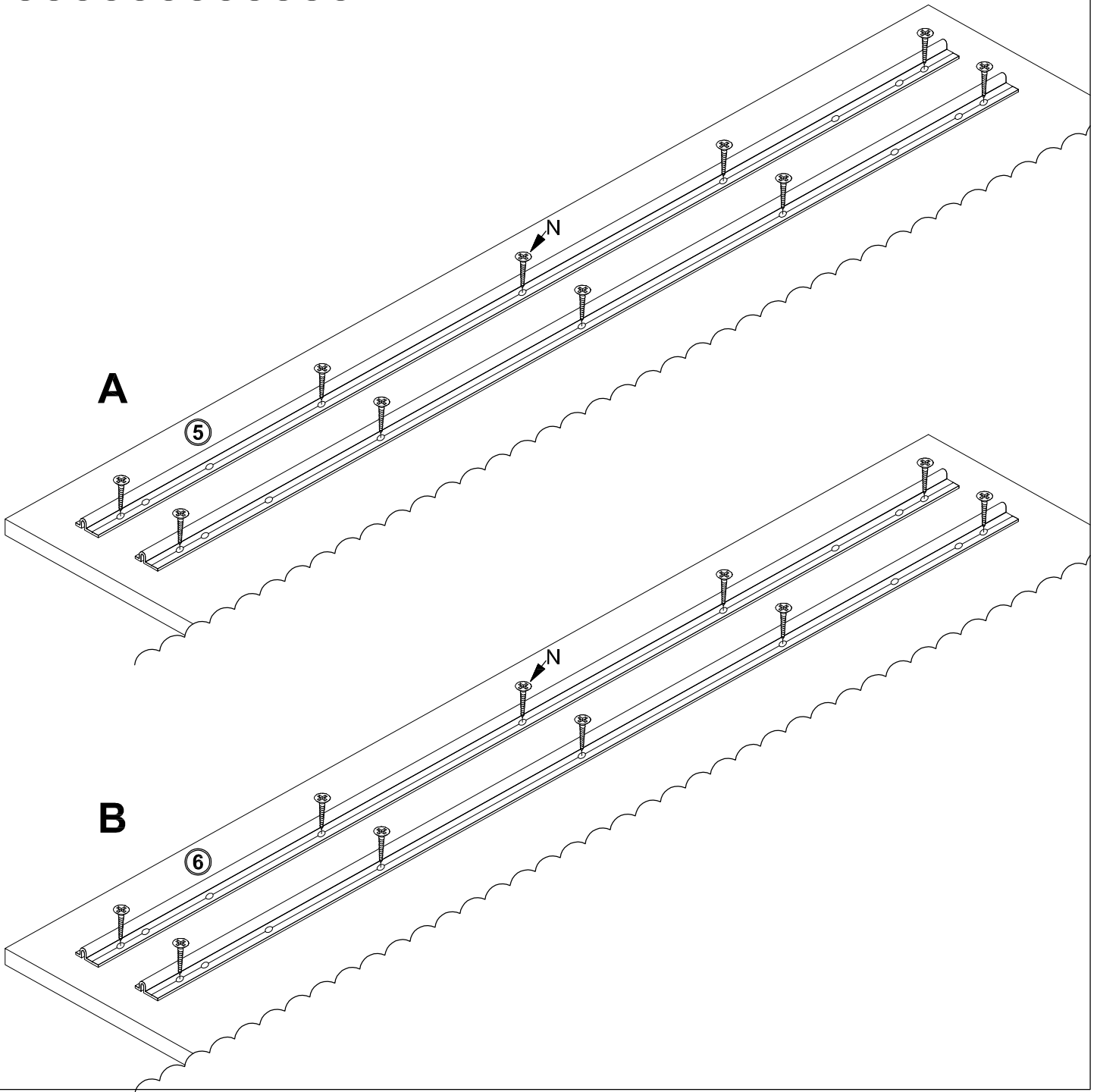
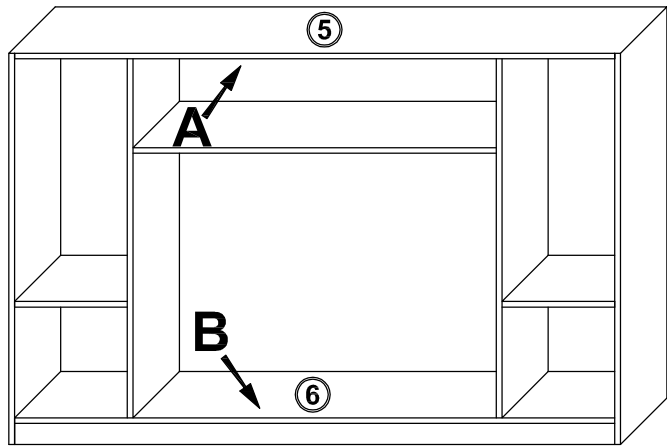
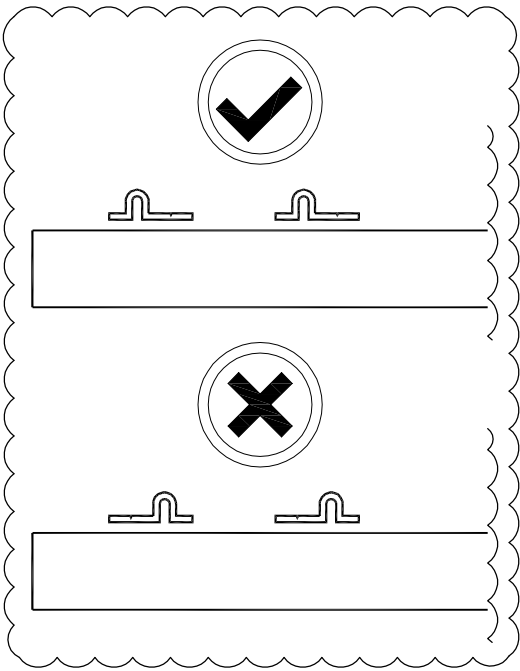

7

1

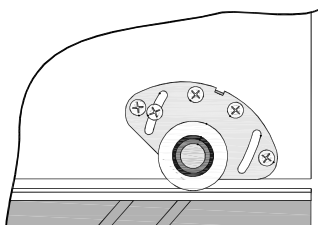
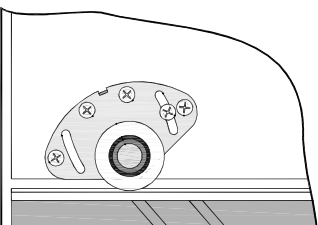
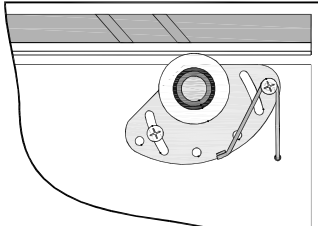
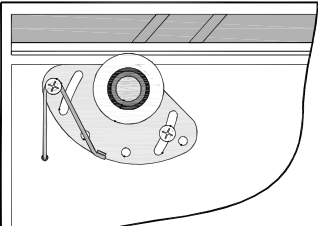
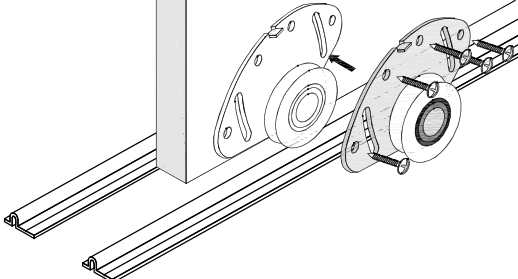
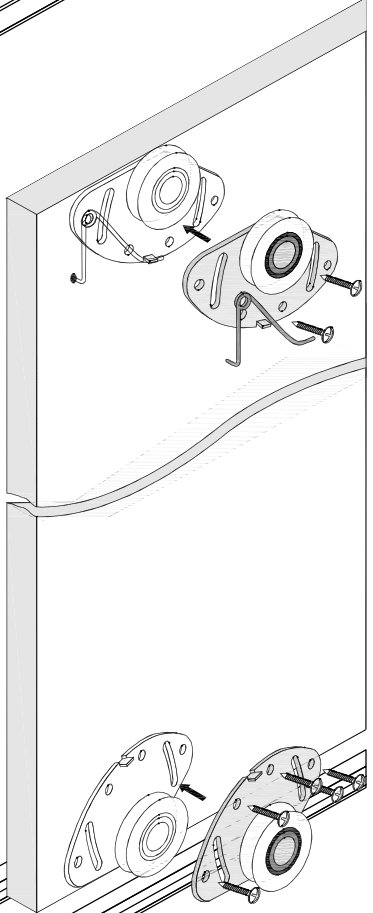
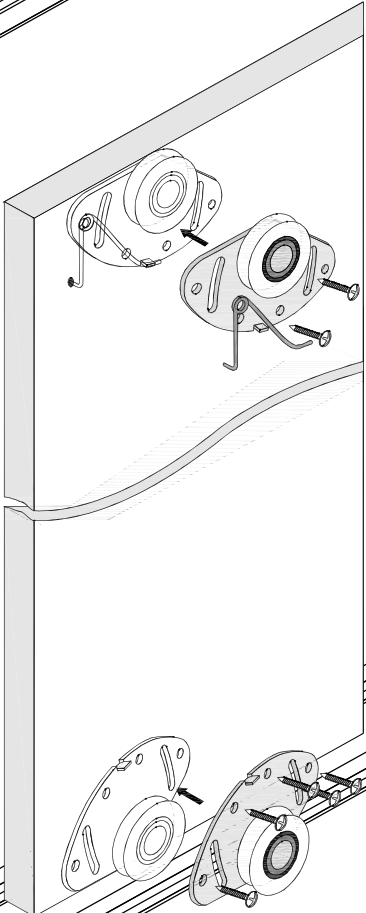
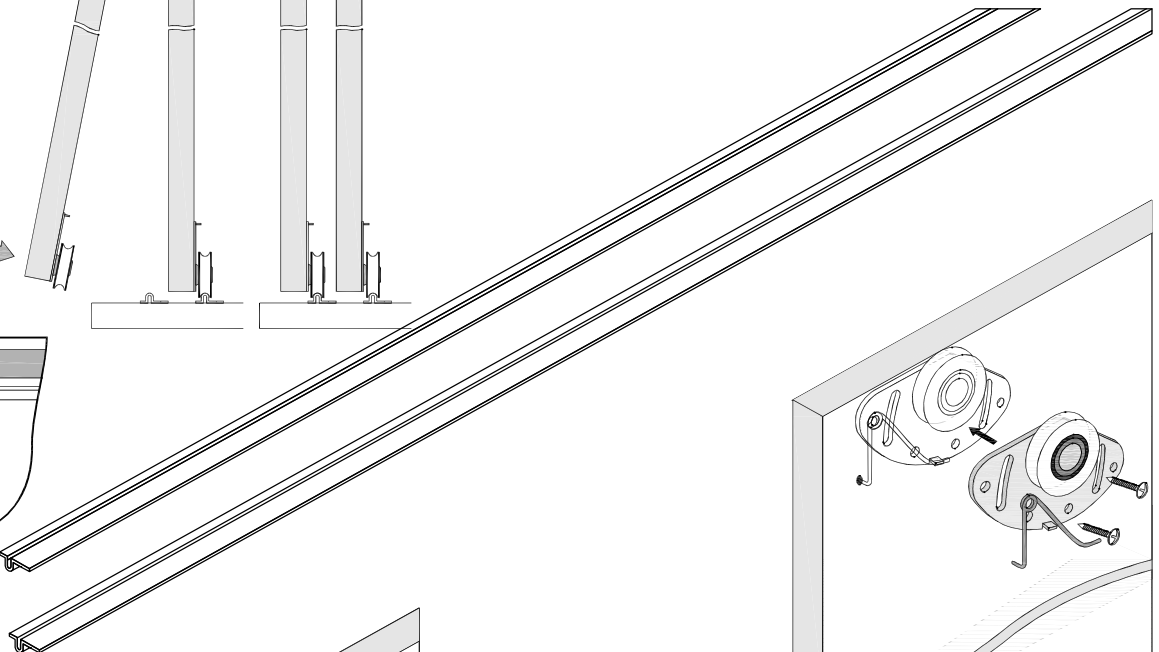
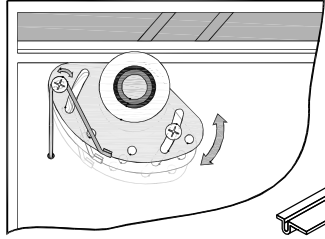
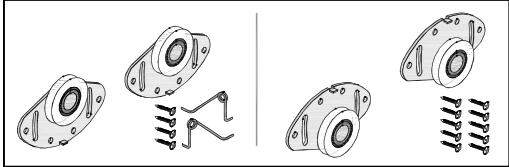

2

3

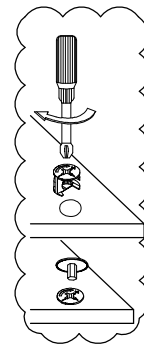
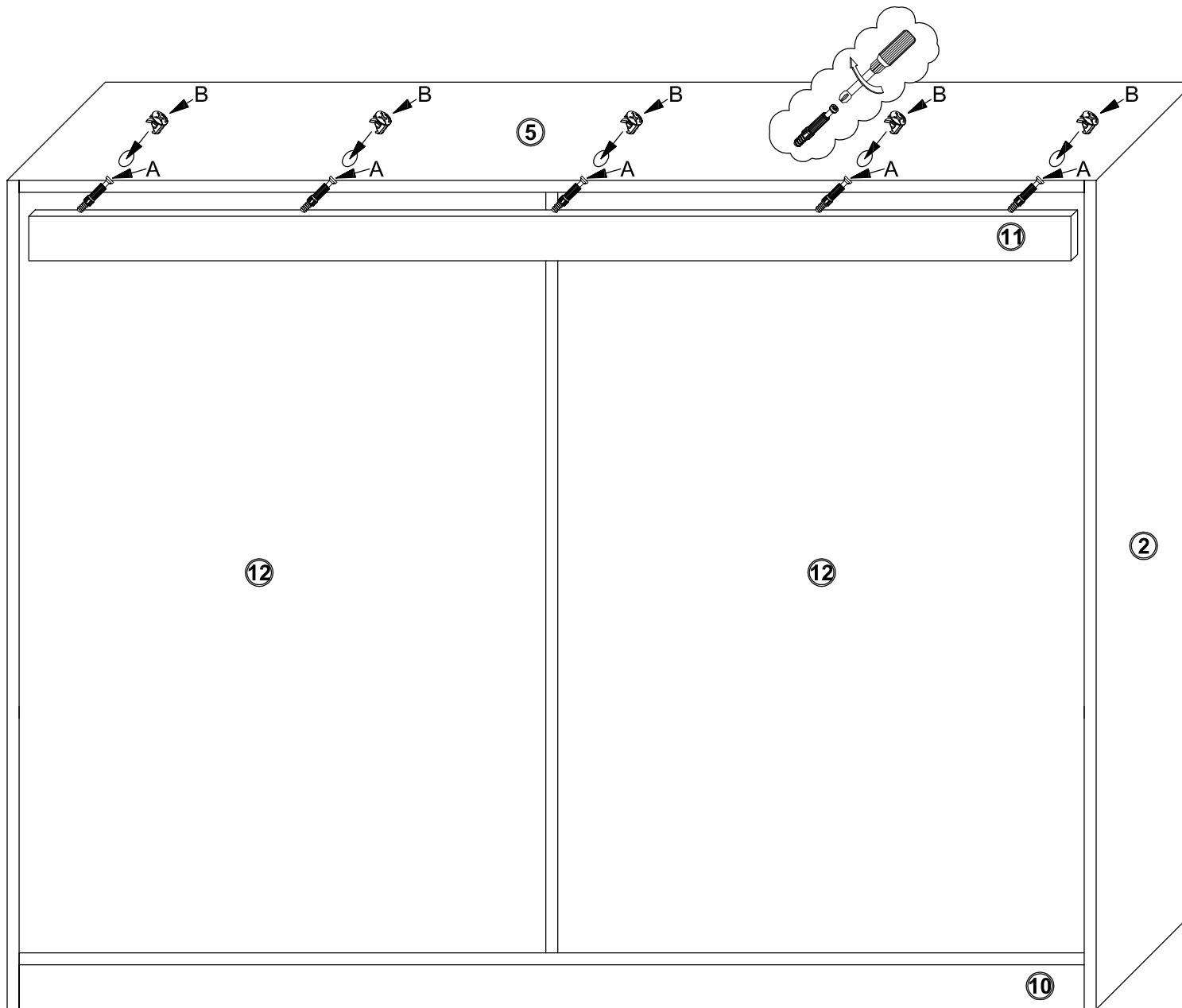

8



		
5 A	5 B	5 C