







TM	MM	ZMB	ZMC	L-68	L-76	8x45	8x30	ZR
16	28	14	14	2	4	6	16	4
								
PZ	W4x16	SW	W4x20	G2	U1	W4x16		
4	8	6	6	25	2	4		



1

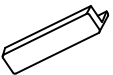

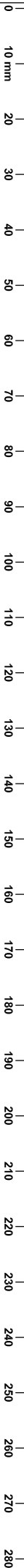
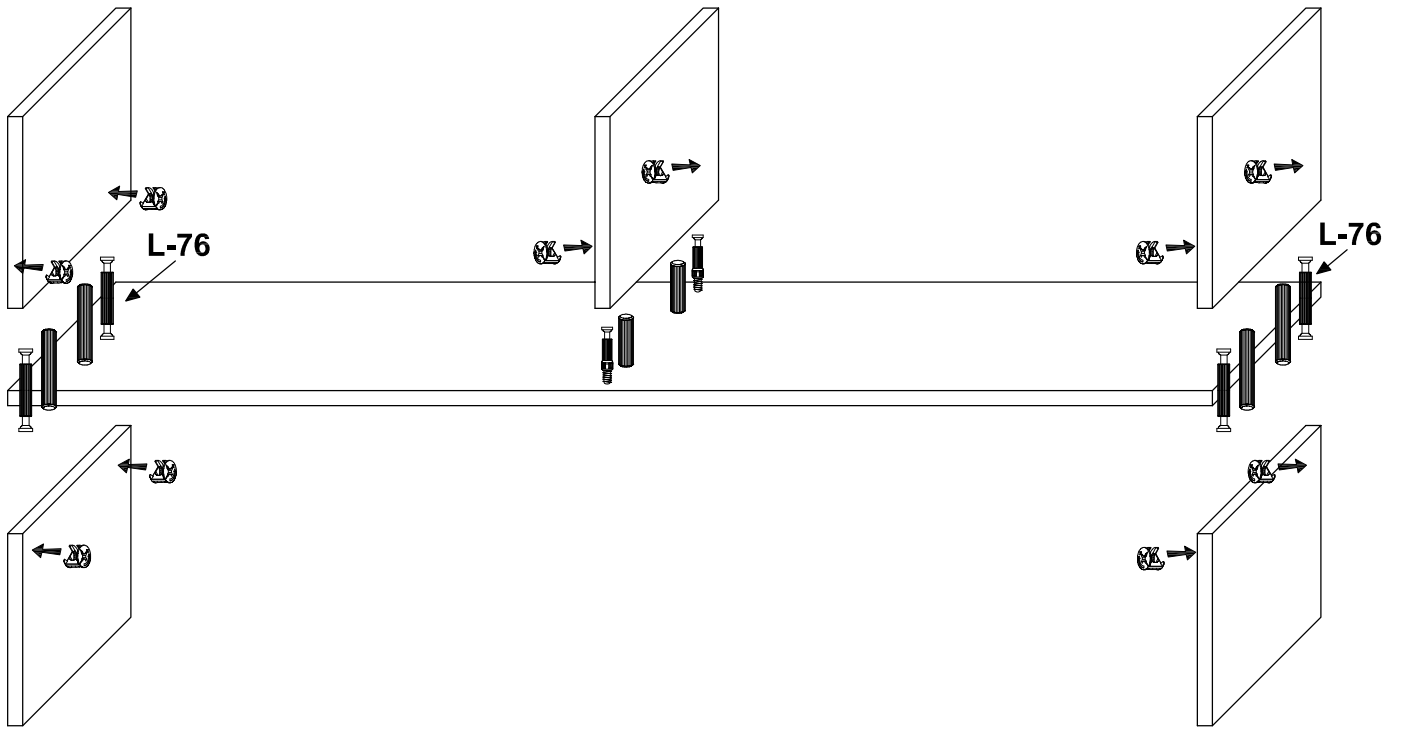
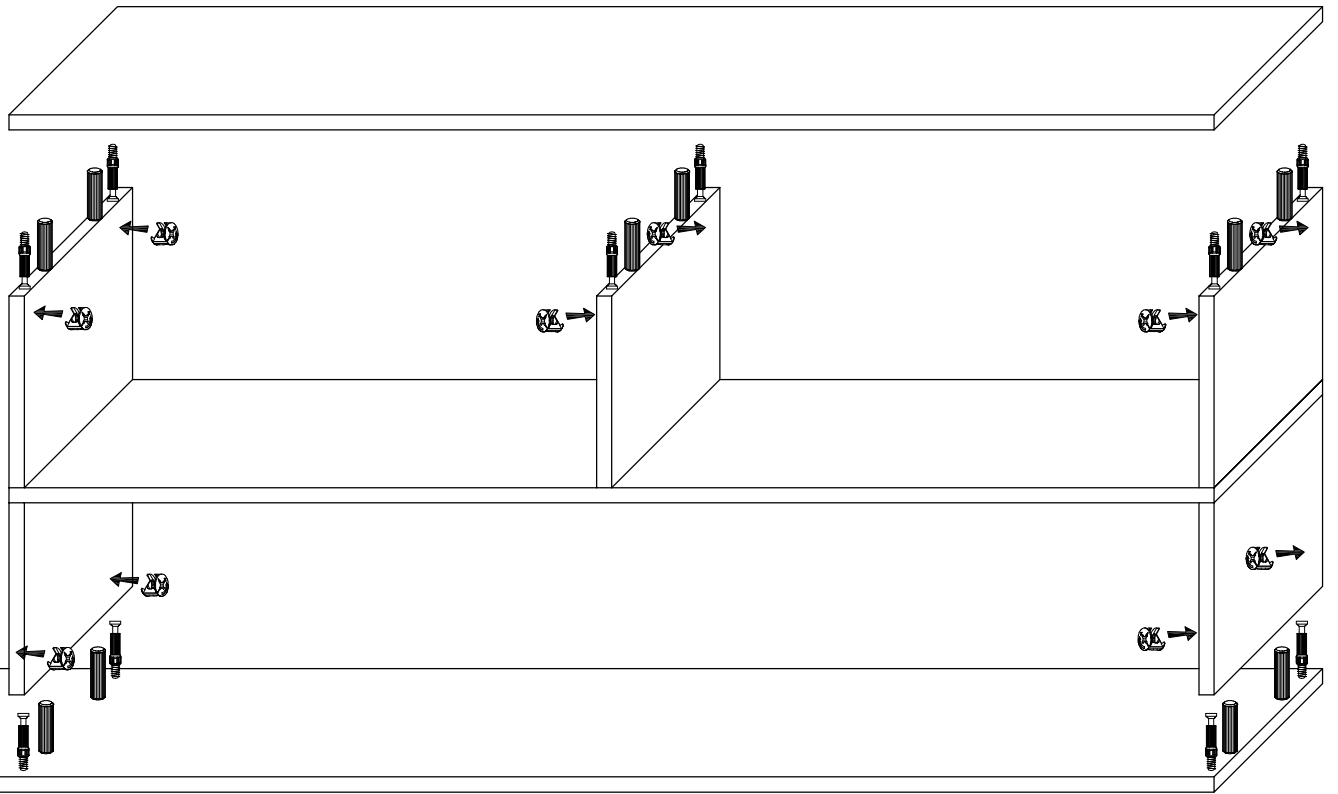
2



3

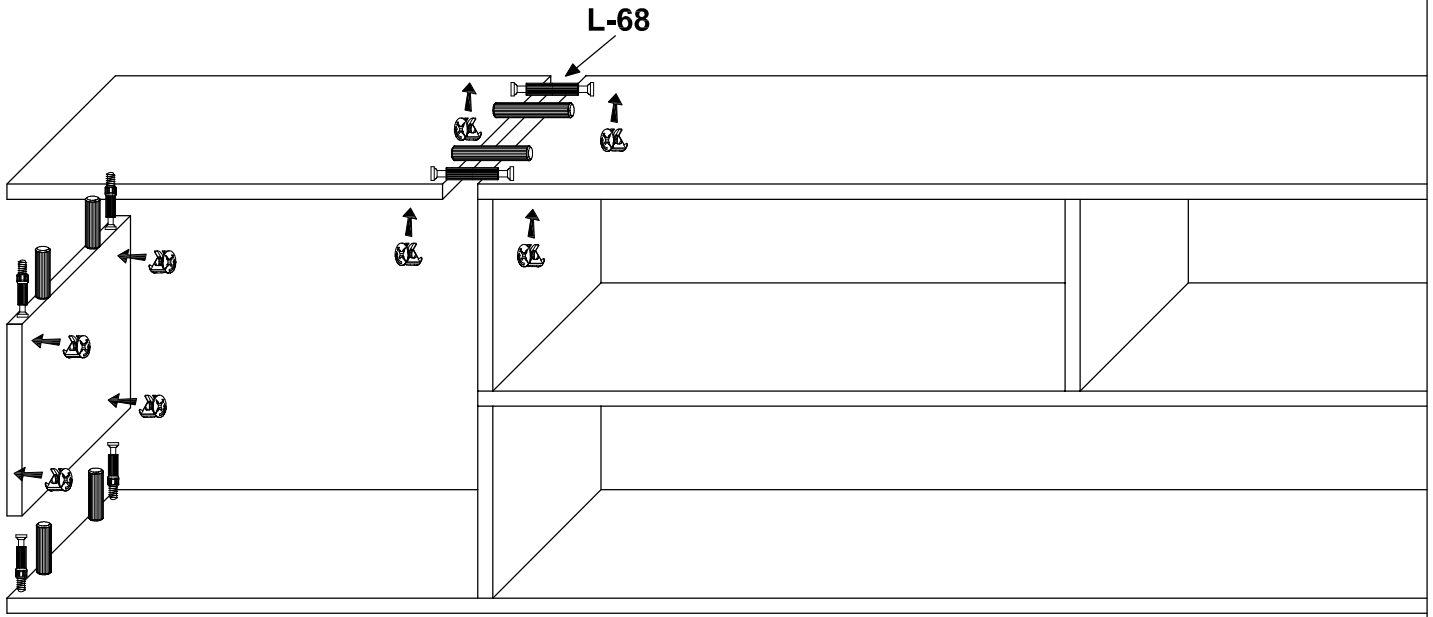

3

