

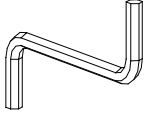

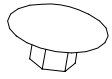
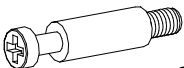

W2  x1	I7a  x7 ø18
--	--

K5  x23	K1  x23 ø15x12
--	---

N31  x6 M8x50
--

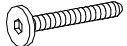
B3  x20 ø8x50
--

B1  x6 ø8x35

1

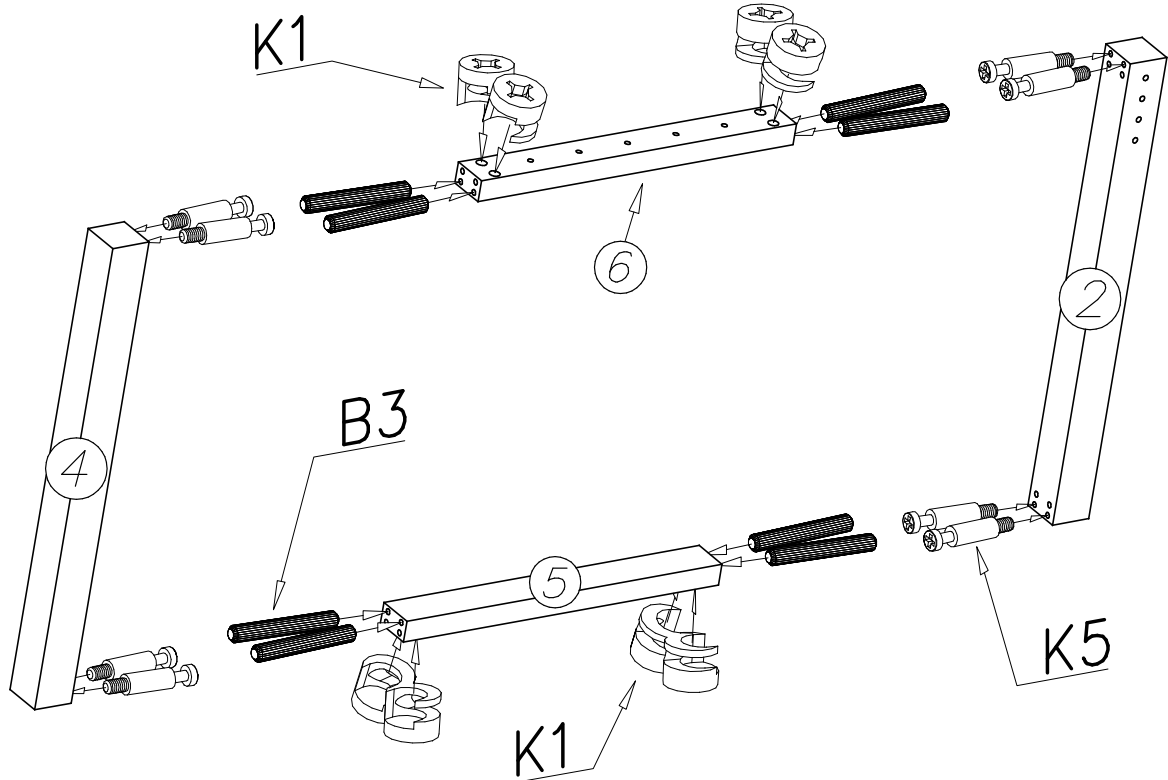
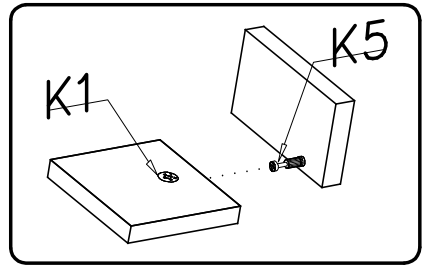
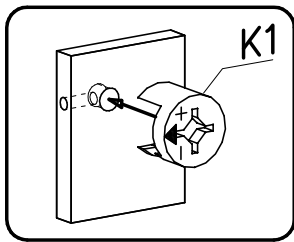
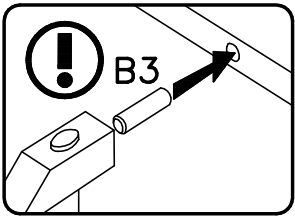
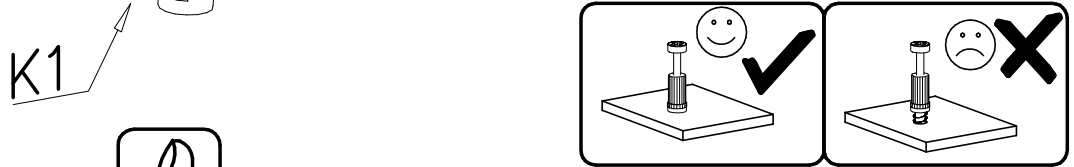
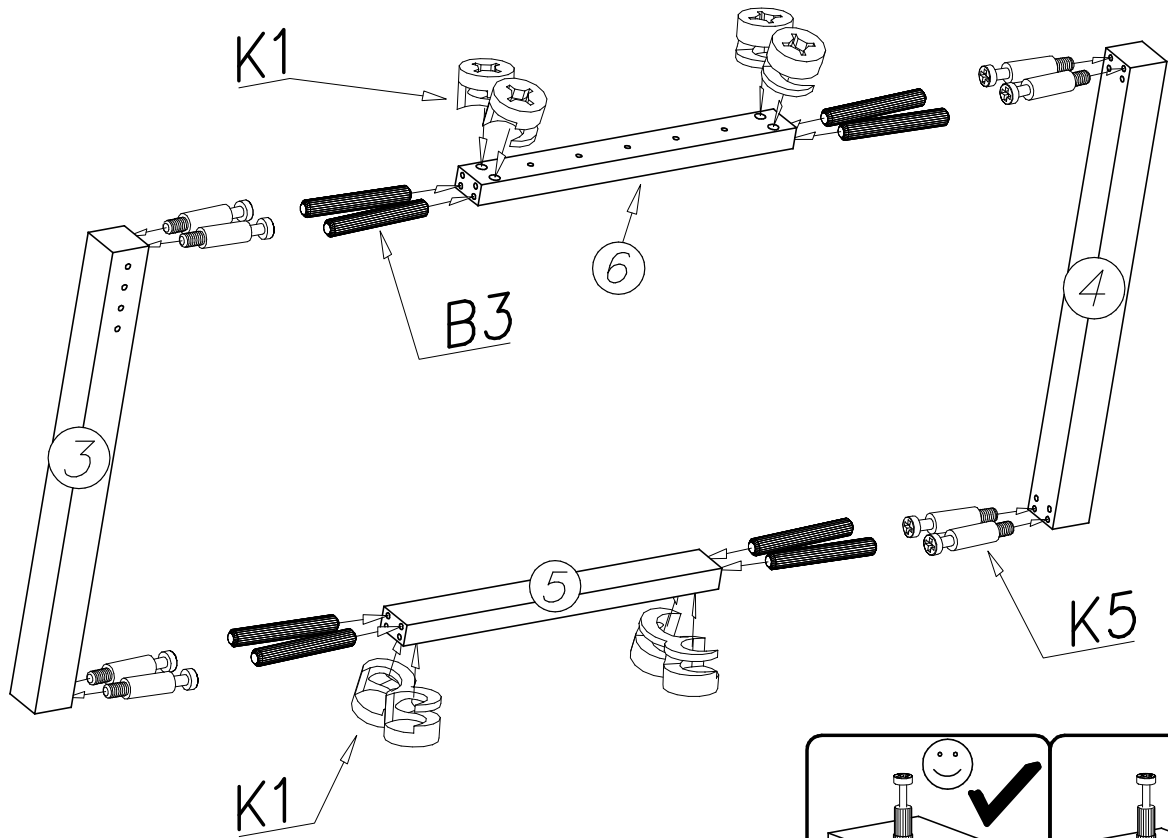

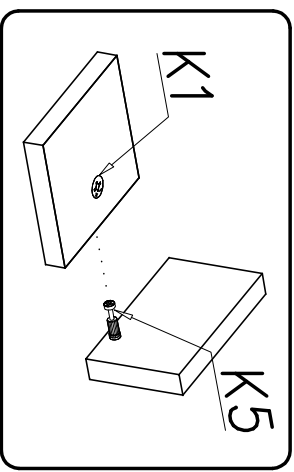
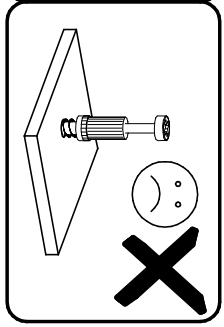
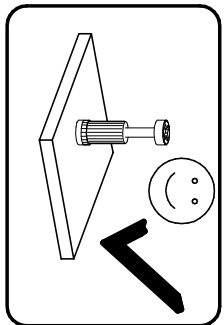
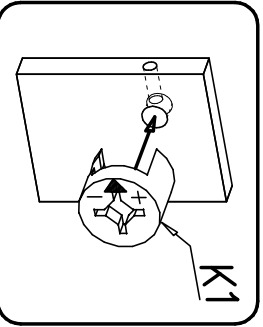
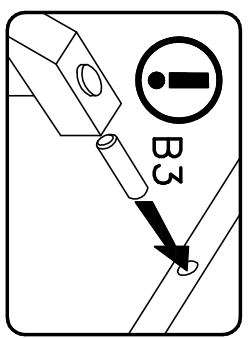
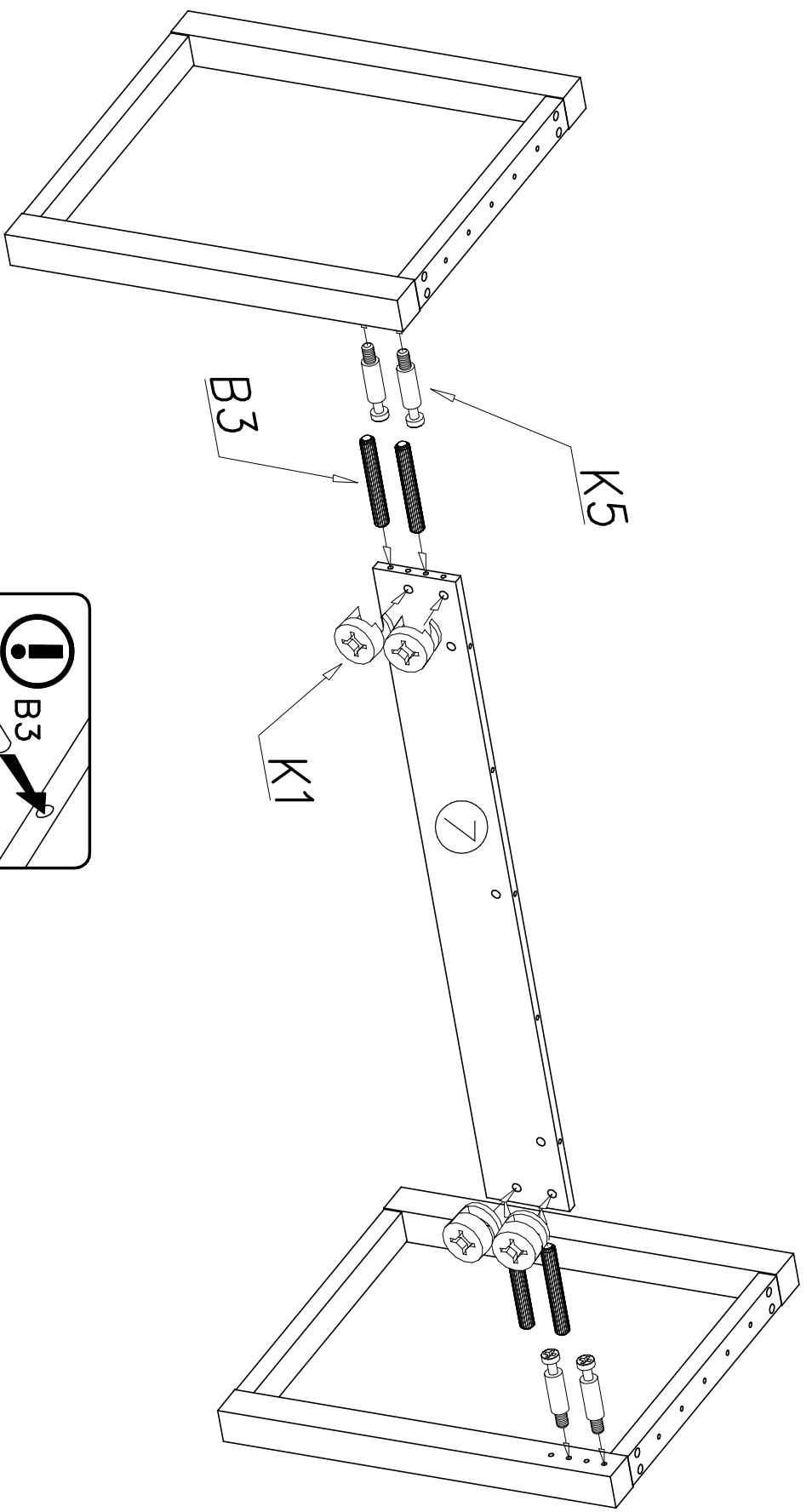

III

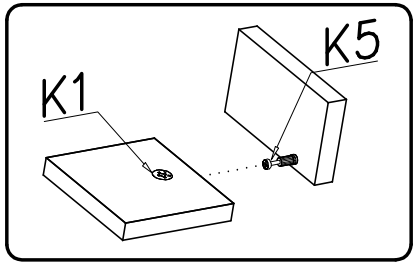
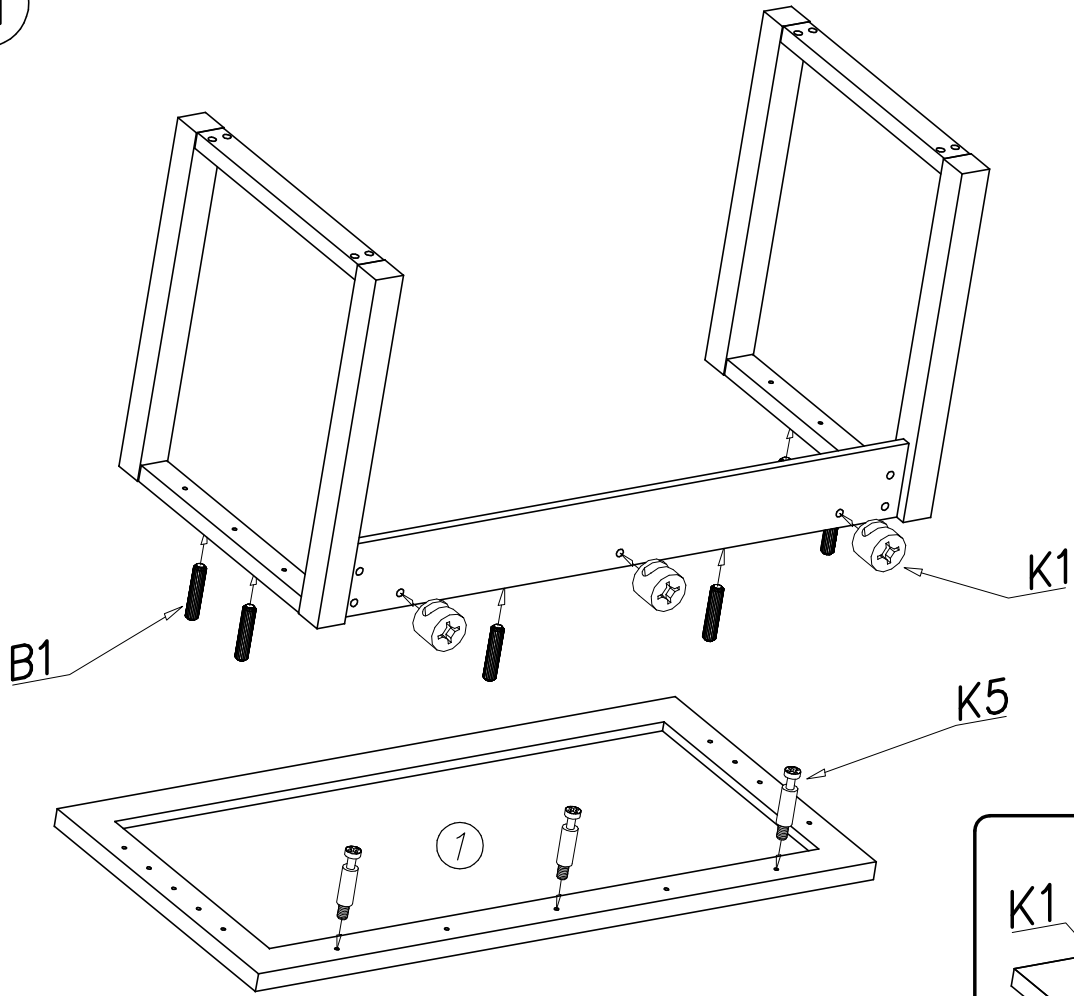

IV

